

How to get the best from **Your** **Microwave Oven**

JVM 61
JVM 61B
PUB #
49-4642



Use and Care of Spacemaker®
model JVM61

Features of your oven p5

How to use the
AUTO ROAST feature p8

How to use the
AUTO START feature p11

Oven shelf guide p20

How to use the
COOK CODE™ feature p14

Save time and money.
Before you request service,
use the Problem Solver p23



Your Direct Line to General Electric
The GE Answer Center® 800.626.2000

EFFDATE
07-11-84

GENERAL  ELECTRIC

49-4642

Help Us Help You. . .

Read this book carefully.

It will help you operate and maintain your new Microwave Oven properly.

Keep it handy for answers to your questions.

If you don't understand something or need more help. . .

Call, toll free:

The GE Answer Center™

800.626.2000

consumer information service

or write: (include your phone number);

Consumer Affairs
General Electric Company
Appliance Park
Louisville, KY 40225

Write down the model and serial numbers.

You'll find them on a label inside the oven on the upper left side.

These numbers are also on the Consumer Product Ownership Registration Card that came with your Microwave Oven. Before sending in this card, please write these numbers here:

Model No. _____

Serial No. _____

Use these numbers in any correspondence or service calls concerning your Microwave Oven.

This microwave oven is UL listed for installation over electric and gas ranges.

Optional Accessory

Available at extra-cost from your GE supplier.

JX80 Charcoal Filter Kit

Add for non-vented installation.

Be sure your Microwave Oven is registered.

It is important that we, the manufacturer, know the location of your Microwave Oven should a need occur for adjustments.

Your supplier is responsible for registering you as the owner.

Please check with your supplier to be sure he has done so; also send in your Consumer Product Ownership Registration Card. If you move, or if you are not the original purchaser please write to us, stating model and serial numbers. **This appliance must be registered. Please be certain that it is.**

Write to:

General Electric Company
Range Product Service
Appliance Park
Louisville, KY 40225

If you received a damaged oven. . .

immediately contact the dealer (or builder) that sold you the Microwave Oven.

Save time and money.

Before you request service, check the Problem Solver on page 23. It lists minor causes of operating problems that you can correct yourself.

The electric output of this microwave oven is 600 Watts.

PRECAUTIONS TO AVOID POSSIBLE EXPOSURE TO EXCESSIVE MICROWAVE ENERGY

(a) **Do Not Attempt** to operate this oven with the door open since open door operation can result in harmful exposure to microwave energy. It is important not to defeat or tamper with the safety interlocks.

(b) **Do Not Place** any object between the oven front face and the door or allow soil or cleaner residue to accumulate on sealing surfaces.

(c) **Do Not Operate** the oven if it is damaged. It is particularly important that the oven door close properly and that there is no damage to the:

(1) door (bent)

(2) hinges and latches (broken or loosened)

(3) door seals and sealing surfaces.

(d) **The Oven Should not be** adjusted or repaired by anyone except properly qualified service personnel.

Contents

Before Microwaving	2
Safety Instructions	3-4
Features of Your Oven	5
Cooking Complete Reminder	5
Set the Clock	6
Touch Control Panel	6-7
Automatic Roasting & Chart	8-9
Defrosting	10
Time Cook	11
AUTO START	11
Temp Cook/Hold	12
MIN/SEC Timer	13
COOK CODE™ Control	14
COOK CODE™ Control Guide ..	15
Care of Your Oven	17-18
The Exhaust Feature	19
Oven Shelf Guide	20-21
Grounding Instructions	22
The Problem Solver	23
Consumer Services	27
Warranty	Back Cover

Microwaving Tips

● Make sure all utensils used in your microwave oven are labeled "suitable for microwaving". Check your Cookbook for specific test to determine "microwave-safe" utensils.

● Paper towels, wax paper, and plastic wrap can be used to cover dishes in order to retain moisture and prevent spattering.

● Some microwaved foods require stirring, rotating, or rearranging. Check your Cookbook for specific instructions.

● Some foods such as unshelled eggs and hot dogs must be pierced to allow steam to escape during cooking.

IMPORTANT SAFETY INSTRUCTIONS

Read all instructions before using this appliance.

When using electrical appliances basic safety precautions should be followed, including the following:

WARNING—To reduce the risk of burns, electric shock, fire, injury to persons or exposure to excessive microwave energy:

● Use this appliance only for its intended use as described in this manual.

● Read and follow the specific "PRECAUTIONS TO AVOID POSSIBLE EXPOSURE TO EXCESSIVE MICROWAVE ENERGY" found on page 2.

● This appliance must be grounded. Connect only to properly grounded outlet. See "GROUNDING INSTRUCTIONS" found on page 22.

● For best operation, plug this appliance into its own electrical outlet, to prevent flickering of lights, blowing of fuse or tripping of circuit breaker.

● Install or locate this appliance only in accordance with the provided installation instructions.

● Do not cover or block any openings on the appliance.

● Do not use outdoors.

● Do not immerse power cord or plug in water.

● Keep power cord away from heated surfaces.

● Do not let power cord hang over edge of table or counter.

● Do not operate this appliance if it has a damaged power cord or plug, if it is not working properly, or if it has been damaged or dropped.

● This appliance should be serviced only by qualified service personnel. Contact nearest authorized service facility for examination, repair or adjustment.

● As with any appliance, close supervision is necessary when used by children.

● See door cleaning instructions on page 17.

● To reduce the risk of fire in the oven cavity:

—Do not overcook food. Carefully attend appliance if paper, plastic, or other combustible materials are placed inside the oven to facilitate cooking.

—Remove wire twist-ties from paper or plastic bags before placing bag in oven.

—Do not use your microwave oven to dry newspapers.

—**Paper towels and napkins, wax paper.** Recycled paper products can contain metal flecks which may cause arcing or ignite. Paper products containing nylon or nylon filaments should be avoided, as they may also ignite.

—**Do not pop popcorn in your microwave oven unless in a special microwave popcorn accessory or unless you use popcorn labeled for use in microwave ovens.**

—**Do not operate the oven while empty to avoid damage to the oven and the danger of fire.** If by accident the oven should run empty a minute or two, no harm is done. However, try to avoid operating the oven empty at all times—it saves energy and prolongs life of the oven.

—If materials inside the oven should ignite, keep oven door closed, turn oven off, and disconnect the power cord, or shut off power at the fuse or circuit breaker panel.

● Some products such as whole eggs and sealed containers—for example, closed glass jars—may explode and should not be heated in this oven.

● **Avoid heating baby food in glass jars, even without their lids; especially meat and egg mixtures.**

(continued next page)

IMPORTANT SAFETY INSTRUCTIONS

(continued)

- **Use metal only as directed in Cookbook.** Metal strips as used on meat, roasts are helpful when used as shown in Cookbook. TV dinners may be cooked in metal trays but when using shelf they must be replaced in their box. However, when using metal in microwave oven, **keep metal (other than metal shelf) at least 1-inch away from sides of oven.**
- **Cooking utensils may become hot** because of heat transferred from the heated food. This is especially true if plastic wrap has been covering the top and handles of the utensil. Potholders may be needed to handle the utensil.
- **Sometimes, the oven floor can become too hot to touch.** Be careful touching the floor during and after cooking.
- **Do not use any thermometer** in food you are microwaving unless that thermometer is designed or recommended for use in the microwave oven.
- **Remove the temperature probe from the oven when not using it** to cook with. If you leave the probe inside the oven without inserting it in food or liquid, and turn on microwave energy, it can create electrical arcing in the oven, and damage oven walls.
- **Plastic Utensils**—Plastic utensils designed for microwave cooking are very useful, but should be used carefully. Even microwave plastic may not be as tolerant of overcooking conditions as are glass or ceramic materials and may soften or char if subjected to short periods of overcooking. In longer exposures to overcooking, the food and utensils could ignite. For these reasons: 1) Use microwave plastics only “and use them” in strict compliance with the utensil manufacturer’s recommendations. 2) Do not subject empty utensils to microwaving. 3) Do not permit children to use plastic utensils without complete supervision.
- **Don’t defrost frozen beverages** in narrow necked bottles; especially carbonated ones. Even if the container is opened, pressure can build up. This can cause the container to burst, resulting in injury.
- **When cooking pork** follow our directions exactly and always cook the meat to at least 170°. This assures that, in the remote possibility that trichina may be present in the meat, it will be killed and meat will be safe to eat.
- **Boiling eggs (in and out of shell) is not recommended** for microwave cooking. Pressure can build up inside egg yolk and may cause it to burst, resulting in injury.
- **Foods with unbroken outer “skin”** such as potatoes, hot dogs or sausages, tomatoes, apples, chicken livers and other giblets, and eggs (see above) should be pierced to allow steam to escape during cooking.
- **“Boilable” cooking pouches and tightly closed plastic bags** should be slit, pierced or vented as directed in Cookbook. If they are not, plastic could burst during or immediately after cooking, possibly resulting in injury. Also, plastic storage containers should be at least partially uncovered because they form a tight seal. When cooking with containers tightly covered with plastic wrap, remove covering carefully and direct steam away from hands and face.
- **Use of the shelf accessory.**
 - Remove the shelf from oven when not in use.
 - Do not store or cook with shelf on floor of oven. Product damage may result.
 - Use potholders when handling the shelf and utensils. They may be hot.
 - Do not use microwave browning dish on shelf. The shelf could overheat.

THE HOOD:

- **Have it installed and properly grounded by a qualified installer.** See the special installation booklet packed with the microwave oven.
- **The vent fan in your Space-maker® oven will operate automatically under certain conditions (see Automatic Fan Feature, page 7). While the fan is operating caution is required to prevent the starting and spreading of accidental cooking fires while the vent fan is in use. For this reason:**
 - Never leave surface units unattended at high heat settings. Boilover causes smoking and greasy spillovers that may ignite and spread if vent fan is operating. To minimize automatic fan operation, use adequate sized utensils and use high heat settings only when necessary.
 - In the event of a grease fire, smother flaming pan on surface unit by covering pan completely with well-fitting lid, cookie sheet or flat tray.
 - Never flame foods under the oven with the vent fan operating because it may spread the flames.
 - Keep hood and grease filters clean, according to instructions on pages 18 and 19, to maintain good venting and avoid grease fires.

SAVE THESE INSTRUCTIONS

Features of Your Microwave Oven

Cooking Complete Reminder

(For all AUTO ROAST codes except code 6, TIME COOK, DEFROST and COOK CODE™ cycles:)

To remind you that you have food in the oven, the oven will beep once a minute until you either open the oven door or touch the CLEAR/OFF pad.

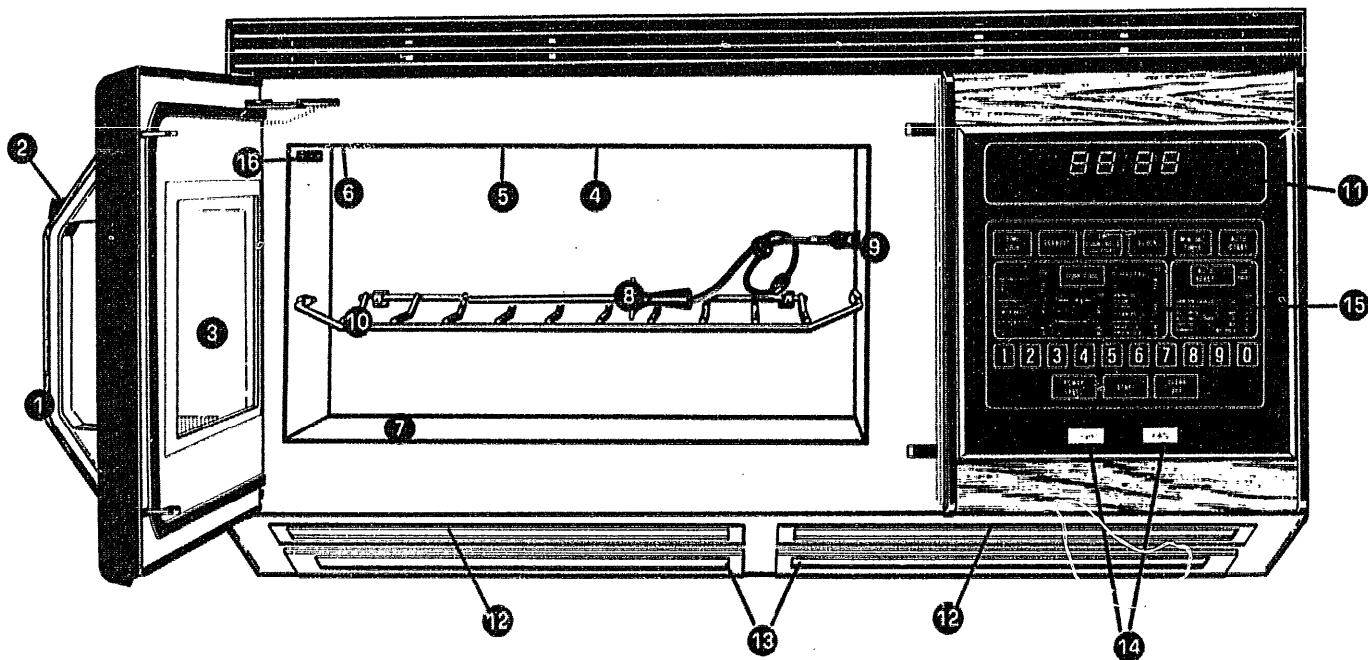

1. **Door Handle.** Oven doesn't operate unless door is securely latched.

2. **Door Latch.** Push in to open door.

3. **Viewing Window with Metal Shield.** Metal screen permits viewing of foods and keeps microwaves confined inside oven.

4. **Mode Stirrer Cover.** Protects the microwave energy distributing system. Do not remove this cover. Doing so will damage the oven.

5. **Oven Vent.**

6. **Oven Interior Light.** Turns on when the door is opened or when the oven is operating.

7. **Oven Floor.**

8. **MICROTHERMOMETER™ temperature probe.** Use with TEMP COOK/HOLD and AUTO ROAST functions only.

9. **Receptacle for Temperature Probe.** Temperature Probe must be securely inserted into receptacle when using TEMP COOK/HOLD or AUTO ROAST.

10. **Two Position Metal Shelf.** Lets you microwave several foods at once. When this shelf is not in use, please remove from the oven. (For complete use of the shelf see pages 20-21.)

11. **Touch Control Panel and Display.** See next page for instructions.

12. **Grease Filters.**

13. **Cooktop Light.**

14. **Hood Controls:**
Fan Switch. Press once for high and twice for low speed. Press again for off.
Lamp Switch. Push and release for light.

15. **Cooking Chart.** Quick reference Codes for many frequently prepared foods.

16. **Model and Serial Numbers.**

Features of Your Touch Control Panel

The Touch Control Panel allows you to set the oven controls electronically with the touch of a finger. It's designed to be easy to use and understand. With your microwave oven, you have the option of using your COOK CODE™ control for quick and easy convenience cooking. Or you may make your own programs to suit your individualized cooking style.

DISPLAY. Displays time of day, time or temperature during cooking functions, power level being used, cooking mode and instructions.

TEMP COOK/HOLD. Use the temperature probe to cook by using a preset temperature. Once oven reaches preset temperature, it switches to HOLD setting and maintains that temperature until you touch the CLEAR/OFF pad. (See page 12.)

DEFROST. Gentle, generally uniform thawing at automatic Power Level 3, (or change power level after entering defrosting time. See page 10.)

TIME COOK. Microwave for a preset amount of time using automatic Power Level 10 (or change power level after entering cooking time. See page 11.)

COOK CODE™ CONTROL. Use this pad as a shortcut method for entering cooking time and power level. (See page 14.)

NUMBER PADS. Touch these pads to enter cooking, defrosting time, time of day, temperature, Power Level and Cook Codes.

POWER LEVEL. Touch this pad before entering another power level number if you want to change from automatic Power Level 10 (HIGH) for cooking or Power Level 3 (LOW) for defrosting.

"EE EE" Appears On Display:

- When using TEMP COOK/HOLD function, you have entered a temperature less than 90° or more than 199°.
- When using AUTO START, you have not entered a valid clock time.
- When setting CLOCK, you have not entered a clock time.
- When using COOK CODE™, you have not entered a valid Code. Code must be 2 or 3 digits.

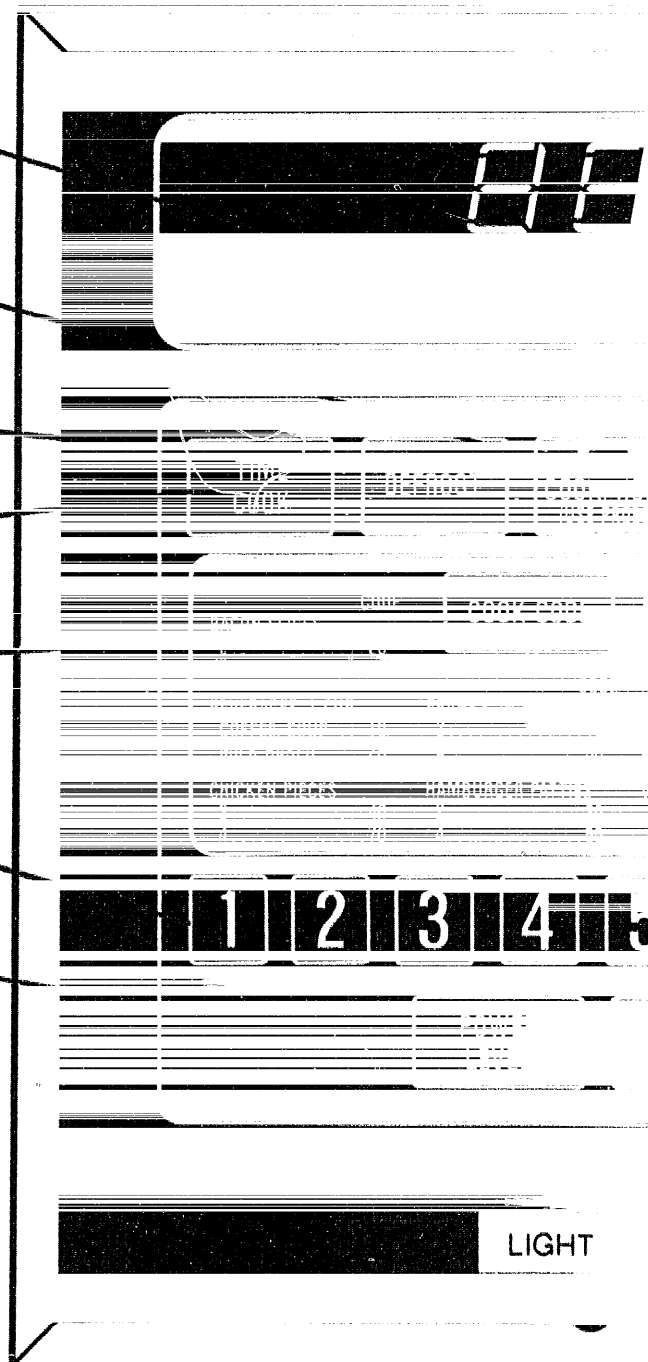



IM Appears On Display:
 Probe has been forgotten when AUTO ROAST or
 TEMP COOK/HOLD functions are being used.
 Probe is not securely seated in oven wall
 receptacle.

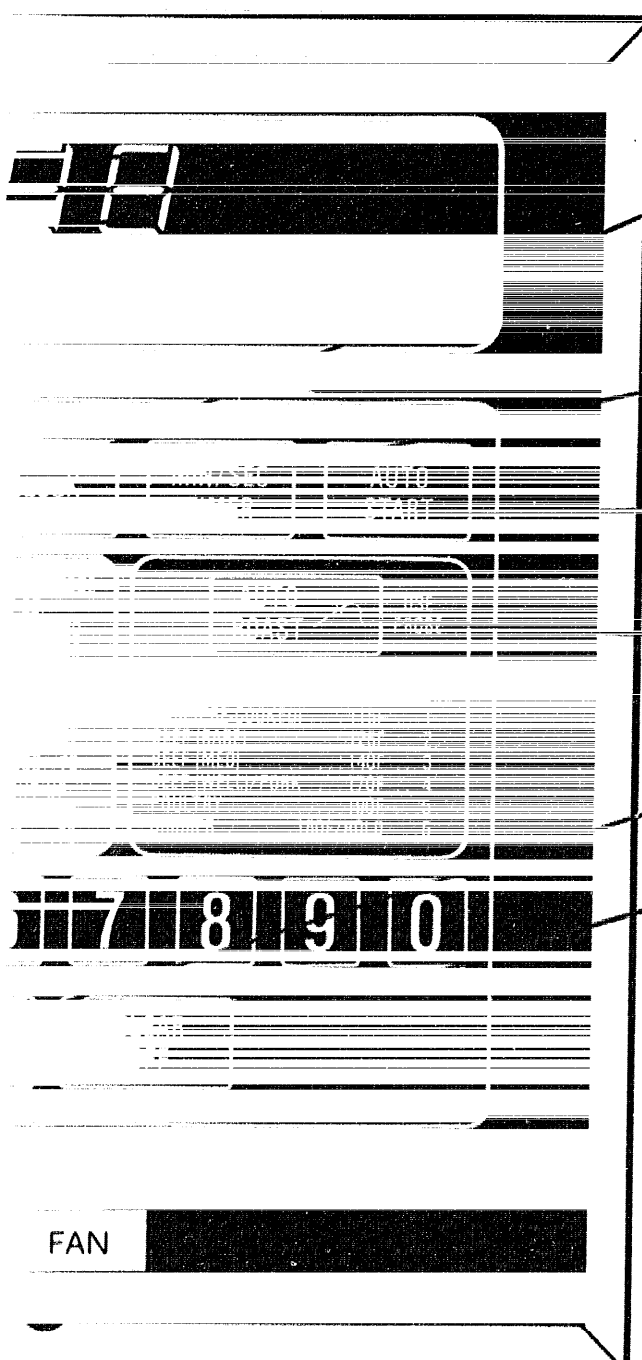

CLOCK. Touch this pad to enter time of day or check time of day while microwaving. To set clock, first touch CLOCK pad and then enter time of day. For example, if time is 1:30, touch number pads 1, 3, and 0 and 1:30 will appear in display. Touch START pad. To reset or change time, simply repeat above process.

MIN/SEC TIMER. This feature uses no microwave energy. It functions as either a kitchen timer, as a holding period after defrost or as a delay timer before time or temperature cooking. (See page 13.)

AUTO START. Allows you to program your oven to begin cooking at a preset time of day—up to a 12 hour delay. (See page 11.)

AUTO ROAST. Insert probe, touch this pad, and desired number pad for Code to slow-cook or temperature cook meat with automatic preset program. (See page 8.)

START. After all selections are made, touch this pad to start oven.

CLEAR/OFF. When touched, it shuts off the oven and erases all settings (except time of day).

AUTOMATIC FAN FEATURE. Cooking appliances installed under the oven might, under some heavy usage conditions, cause temperatures high enough to overheat some internal parts of the microwave oven.

To prevent overheating from taking place, the vent fan is designed to automatically turn on at low speed if excessive temperatures occur. Should this happen, the fan cannot be manually turned off; it will automatically turn off when the internal parts have cooled. The fan may stay on up to approximately 30 minutes after the range and microwave oven controls have been turned off.

Automatic Roasting

See Auto Roast Chart on page 9.

AUTO ROAST

Auto Roast uses the temperature probe to cook to the desired serving temperature. Unlike Temp Cook/Hold, which uses a single power level, Auto Roast is designed to use up to 3 power settings which automatically switch during roasting, for even and tender cooking results without overcooking.

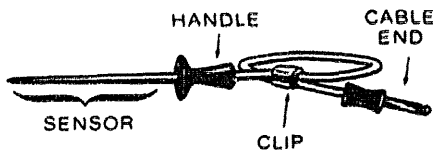

Just as in conventional roasting, only tender roasts should be Auto Roasted until specified internal temperatures are reached. Less tender roasts should be microwaved by time, according to the Cookbook which comes with your oven. Complete information on preparing roasts for microwaving is in your Cookbook.

How to Prepare Roasts for Auto Roasting

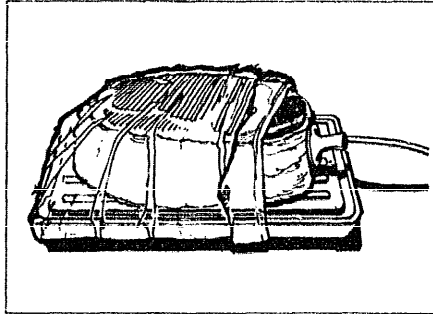

Place tender beef roasts on trivet in microwave-safe dish. Insert probe from the front horizontally into center meaty area not touching bone or fat. Cover with wax paper.

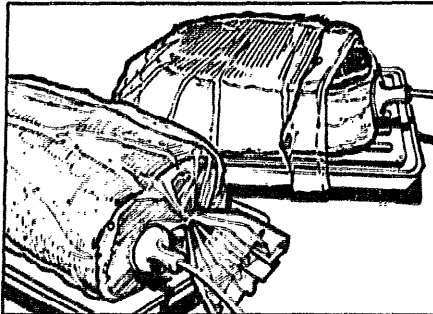

Poultry, pork or ham roasts need no trivet. Add 1/2 cup water to roast dish, cover with plastic wrap. (For cooking bag method, see Cookbook.) Insert probe into center meaty area.

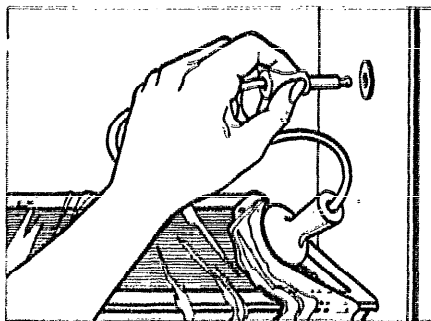

Place meat in oven with probe to the right. Insert cable end of probe firmly into receptacle on oven wall.

How to Auto Roast Beef to Medium

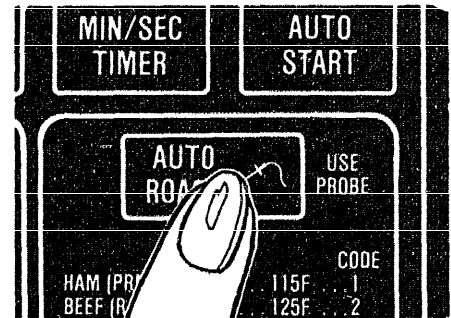

Step 1: Touch AUTO ROAST Pad. Display flashes ENTER CODE. Touch number pad 3. "START" flashes. Touch START.

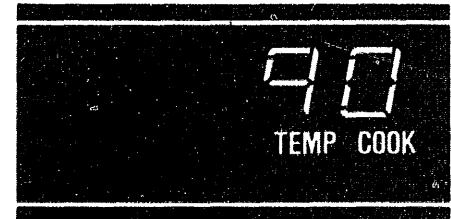

Step 2: Display shows internal food temperature counting up.

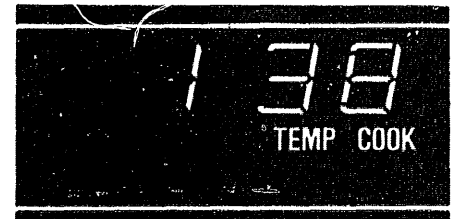

Step 3: Oven monitors internal temperature, automatically switching to lower power as meat's temperature rises. This helps prevent toughening or overcooking.

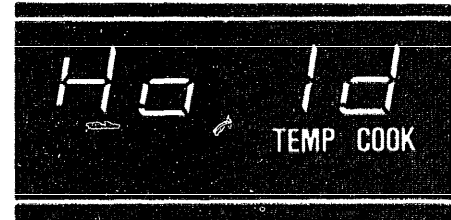

Step 4: After temperature is reached, oven switches to HOLD for 1 hr., then shuts off. Hold prevents overcooking while keeping meat warm.

Step 5: Display will show "End".

Step 6: Open door or touch CLEAR/OFF pad.

Auto Roast Chart

Food	Code	Final Temp	Approx. Time (Min. per lb.)	Hold* Minutes
Beef				
Tender Roast				
Rare	2	125°	12-14	5-10
Medium	3	140°	14-16	10-15
Well	4	170°	17-18	30
Meatloaf (loaf or round)	4	170°	15-20	5-10
Pork				
Loin Roast	4	170°	18-20	20
Precooked Ham	1	115°	11-14	5-10
Poultry				
Whole Chicken (3 lb.)	5	190°	13-15	20
Whole Turkey (up to 12 lbs.)	5	190°	13-15	20
(Insert probe into meatiest area of inner thigh from below end and parallel to leg.)				
Turkey Breast	4	170°	13-15	20
(Insert probe horizontally into meatiest area.)				

*Recommended standing time before serving.

Questions and Answers

Q. Why wasn't my roast fully cooked even though the temperature on the display was correct and Auto Roast was completed.

A. The temperature probe must be properly inserted when you Auto Roast. Check your Cookbook to see what you might have done wrong.

Q. Do some types of trivets work better than others?

A. Yes. Flat glass trivets generally provide more browning to the bottom of meats than plastic trivets. Also, ceramic ridge-bottomed roasting dishes usually work well. Plastic trivets may require meat to be turned over more often than glass trivets do because the grid design and legs let the bottom of the meat stay cooler than glass trivets do.

Q. When I'm cooking with Auto Roast, why doesn't my roast continue to cook during the holding time?

A. When your food reaches finished temperature, the oven automatically switches to a lower heat level. The even temperature that's maintained in the food during this holding period keeps it warm without overcooking.

Automatic Simmer

(Auto Roast Code 6)

Here's how to Automatic Simmer a few popular foods. See your Cookbook for more cooking charts, recipes and techniques.

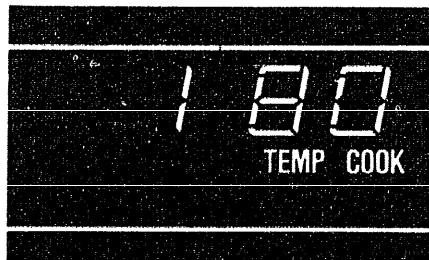

Set Auto Simmer like you do Auto Roast except touch number pad 6. START flashes. Touch START and display shows temperature until food reaches 180°.

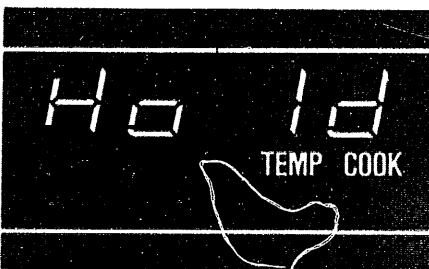

Oven switches to HOLD when food's internal temperature reaches 180° and maintains that temperature until food is done. If stirring is recommended, you can reset the oven by retouching START. Touch CLEAR/OFF when cooking is finished.

Automatic Simmer Chart

Food	Approximate Time/Hrs.
Beef	
Pot Roast*	6-8
Stew	6-8
Chili	11-13
Chicken*	
Stewing	11-12
Broiler/Fryer	4-6
Ham or Pork	
Roast	4-6
Soup	
Stock/Vegetable	3-6
Split Pea	13-15

*For frozen, add 2 to 3 hours.

Defrosting

The Defrost setting is designed for even thawing necessary for large amounts of food and is one of the most important advantages of a microwave oven.

- Power Level 3 is automatically set for defrosting, but you may change this for more flexibility.
- See your Cookbook for defrosting help.

When the oven completes Defrosting, it automatically shuts off. It will then display "End" and beep once a minute until you either open the door or touch the CLEAR/OFF pad.

To become better acquainted with the defrost functions, defrost frozen pork chops using the following steps.

Step 1: Place package of frozen chops in the oven and close door.



Step 2: Touch DEFROST. Display reads :0 and Power Level 3 is automatically set in the oven but does not appear on display. ENTER DEF. TIME flashes.

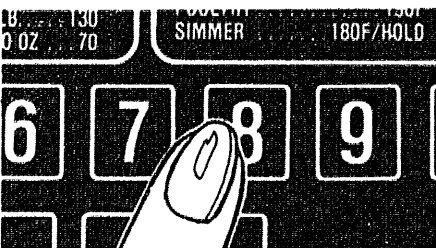

Step 3: Touch 8, 0 and 0 for 8 minutes. DEF. TIME and 8:00 are displayed. If you wish to change Power Level, touch POWER LEVEL pad and then new number.

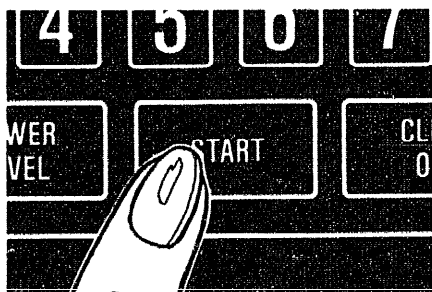

Step 4: Touch START. Time counts down on display. When cycle is completed, the oven signals and automatically shuts off.

Step 5: Turn package over, close door and repeat Steps 2, 3 and 4.

Step 6: When oven signals and shuts off, display will show "End".

Step 7: Open door or touch CLEAR/OFF pad. Remove package and separate chops to finish defrosting.

Defrosting Tips

- Foods frozen in paper or plastic can be defrosted in the package.
- For even defrosting, many foods need to be broken up or separated part of the way through the defrosting time.
- Homemade dinners can be frozen in shallow foil trays and heated for later use. (Do not heat on metal shelf accessory.) Select foods which microwave well.
- Pre-packaged frozen dinners can be defrosted and microwaved.
- Check your Cookbook for other defrosting tips.

Questions and Answers

Q. When I press START, I hear a dull thumping noise. What is it?

A. This sound is normal. It is letting you know the oven is using a Power Level lower than HIGH.

Q. Can I Defrost small items in a hurry?

A. Yes, but they will need more frequent attention than usual. Raise the Power Level after entering the time by touching POWER LEVEL and 7 or 10. Power Level 7 cuts the time about in $\frac{1}{2}$; Power Level 10 cuts the time to approximately $\frac{1}{3}$. During either, rotate or stir food frequently.

Q. Can I open the door during DEFROST to check on the progress of my food?

A. Yes. You may open the door at any time during microwaving. To resume defrosting, close the door and press START.

Q. Why don't the defrosting times in the Cookbook seem right for my food?

A. Cookbook times are average. Defrosting time can vary according to the temperature in your freezer. Set your oven for the time indicated in your Cookbook. If your food is still not completely thawed at the end of that time, re-set your oven and adjust the time accordingly.

Q. Can I select a Power Level other than automatic Power Level 3 for defrosting?

A. Yes. Some smaller foods may be defrosted quicker on higher Power Levels but for even, carefree defrosting, Power Level 3 is suggested. Check the chart in the Cookbook for specific times and Power Levels.

Cooking by Time

The Time Cook feature allows you preset the cooking time.

Power Level 10 is automatically set for time cooking, but you may change this for more flexibility. See your Cookbook.

When the oven completes Time Cooking, it automatically shuts off. It will then display "End" and beep once a minute until you either open the door or touch the CLEAR/OFF pad.

To become better acquainted with Time Cook function, make a cup of coffee by using the following steps.

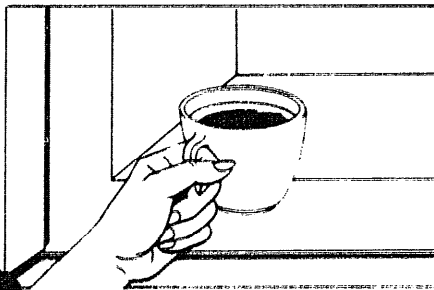

Step 1: Fill a cup 2/3 full of water and add 1 teaspoon of freeze dried coffee. Use a cup that has no metal decoration. Place cup in oven and close door.

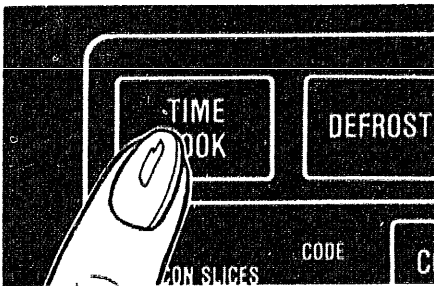

Step 2: Touch TIME COOK. The display shows :0. ENTER COOK TIME flashes. Power Level 10 is automatically set, but does not appear on display.

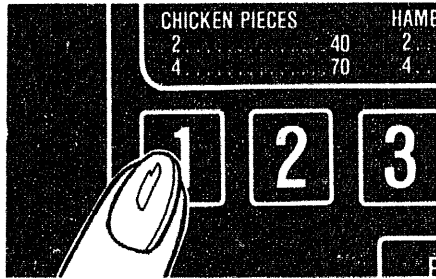

Step 3: Select your time. Touch 1, 2, and 0 for a minute and 20 seconds. TIME COOK and 1:20 are displayed.

If another Power Level is desired, touch POWER LEVEL and the number although Power Level 10 (HIGH) is preferred for this cup of coffee.

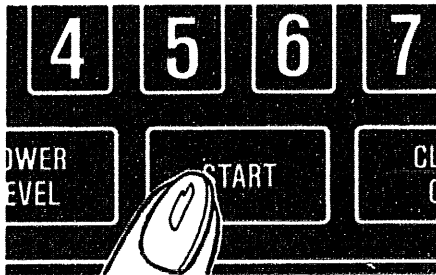

Step 4: Touch START. Time counting down shows on display.

Step 5: When time is up, the oven sounds, oven light and fan shut off. The display will show "End".

Step 6: Open the door or touch CLEAR/OFF pad.

How to Use AUTO START

The AUTO START feature allows you to program your oven to begin cooking at a preset time of day—up to a 12 hour delay.

To use AUTO START

Step 1: Enter your desired cooking program.

Step 2: Touch AUTO START pad (instead of START pad).

Step 3: Enter the time you want the oven to start. (Be sure your microwave oven clock shows the correct time of day.)

Step 4: Touch START pad.

The oven will automatically start at the desired time.

Questions and Answers

Q. I set my oven for the time called for in the recipe but at the end of the time allowed, my dish wasn't done. What happened?

A. Since house power varies due to time or location, many Time Cook recipes give you a time range to prevent overcooking. Set the oven for minimum time, test the food for doneness, and cook your dish a little longer, if necessary.

Q. I want to cook on a Power Level other than HIGH, what do I need to do?

A. To change the Power Level, touch the POWER LEVEL pad after entering desired cooking time. Enter the desired number and then touch START.

Q. Can I interrupt my Time Cook function to check the food?

A. Yes. To resume cooking, simply close the door and touch START. NOTE: Microwave power will not come on until you are ready. You must touch START for cooking to begin.

Q. I touched the number pads and selected my power level. When I touched START, however, my oven didn't come on. Why not?

A. The TIME COOK pad must be touched before setting the number pads or else your oven will not begin cooking.

Q. I tried to change Power Level but the display changed back to cooking time. Why?

A. After touching Power Level pad you only have 4 seconds to enter the number. Try setting controls again.

Cooking by Temperature

For many foods, internal temperature is the best test of doneness.

Roasts or poultry are cooked to your preference when temperature cooking. Heating or reheating foods accurately to a serving temperature you desire is simple and easy.

Temp Cook/Hold takes the guesswork out of cooking because the oven automatically switches to HOLD setting after reaching the preset food temperature and maintains that temperature until you touch the CLEAR/OFF pad.

The Temperature Probe

The temperature probe is a food thermometer that gauges the internal temperature of your food; it must be used when using Temp Cook/Hold or Auto Roast. Follow the directions for use and insertion on page 8.

How to Temp Cook a Rolled Beef Rib Roast to Medium

Step 1: Insert temperature probe as directed in Cookbook and attach probe securely in oven wall. Close the door.

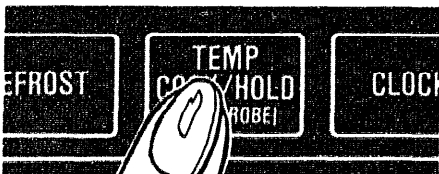

Step 2: Touch TEMP COOK/HOLD. ENTER TEMP COOK flashes and the digit portion of the display is blank.

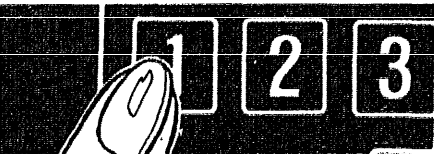

Step 3: Touch 1, 3, 0 for 130°. 130 shows on display. Power Level 10 is automatically set in oven but does not appear on display.

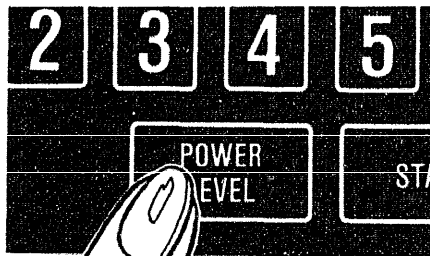

Step 4: Touch POWER LEVEL pad. P-10 shows on display. Touch 5 for MEDIUM power. P-5 shows on display and then display reverts back to set finished temperature.

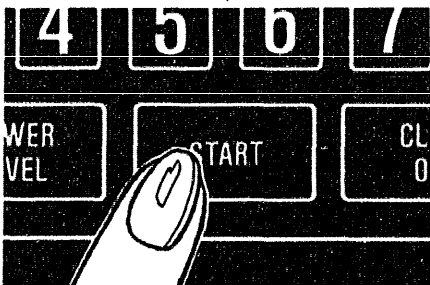

Step 5: Touch START. After food reaches 90°, display shows temperature of food counting up.

Step 6: When 130° is reached, the oven will sound and display HOLD. The oven will then hold the temperature.

Step 7: Touch the CLEAR/OFF pad to stop the cycle.

Step 8: Remove probe and food from the oven.

Cooking Tips

- Use a lower power level setting; it will heat evenly even though requiring more time.
- Be sure frozen food has been completely defrosted before inserting probe. Probe may break off if used in frozen foods.
- Always insert probe into the center of meaty areas; take care not to touch the fat or the bone.
- Insert probe as horizontally as possible into foods as directed in the recipes. Make sure the handle does not touch the food.
- Use the clip to keep the probe in place while heating.
- Cover foods as directed in Cookbook for moisture control and quick heating.

Questions and Answers

Q. After I followed the steps and touched START, a signal sounded and oven did not start. What is wrong?

A. If you set the temperature either below 90° or greater than 199° the oven will not start. To re-enter, touch CLEAR/OFF pad and begin steps again.

Q. Are there any foods I can't Temp Cook?

A. Yes. Delicate butter icings, ice cream, frozen whipped toppings, etc., soften rapidly at warm temperatures. Batters and doughs as well as frozen foods are also difficult to cook precisely with the probe. It is best to Time Cook these foods.

Q. Why did "PR OB" flash on the display after I touched Start?

A. "PR OB" will flash on the display if you have not securely seated the end of the probe into the receptacle in the oven wall or if you touch TEMP COOK/HOLD and have forgotten to use the probe.

Q. Can I leave my probe in the oven if it's not inserted in the food?

A. No. If the probe is left inside the oven, touching the oven wall, and not inserted in food, you may damage the oven.

Q. Can I Temp Cook different portions of food at different temperatures?

A. Yes. The temperature probe gives you the freedom to cook different portions of food at different temperatures to suit individual eating styles. Simply place the probe in the food and change the temperature setting as needed.

How to Use the Minute/Second Timer

The MIN/SEC TIMER has three timing functions:

- It operates as a minute timer.
- It can be set to delay cooking.
- It can be used as a hold setting after defrosting.

The MIN/SEC TIMER operates without microwave energy.

How to Time a 3-Minute Phone Call

1. Touch MIN/SEC TIMER pad. The display shows :0 and ENTER TIME flashes.
2. Touch number pads 3, 0 and 0 (for 3 minutes and no seconds). Display shows 3:00.
3. Touch START. Display shows time counting down.
4. When time is up, oven signals and display shows time of day.

Programming a HOLD Time

The Minute/Second Timer can also be used to program "hold time" between microwave cooking functions. The time can range from one second to 99 minutes and 99 seconds. A HOLD, or "standing" time may be found in some of your own recipes or Cookbook.

To set the oven to delay cooking up to 99 minutes follow Steps 1 and 2 to enter hold time. Then touch TIME COOK pad and enter time before pressing START.

How to Defrost, Hold and Time Cook

Let's say you want to defrost a frozen casserole for 15 minutes, hold for 10 minutes and then Time Cook for 25 minutes. Here's how to do it:

Step 1: Take casserole from freezer and place it in the oven.



Step 2: Touch DEFROST pad.



The display shows :0 and ENTER DEF. TIME flashes.

Step 3: Touch pads 1, 5, 0 and 0 for 15 minutes defrosting time. 15:00 appears on display. (Defrosting is automatically set on Power Level 3 but can be changed by touching POWER LEVEL pad and the new Power Level.)

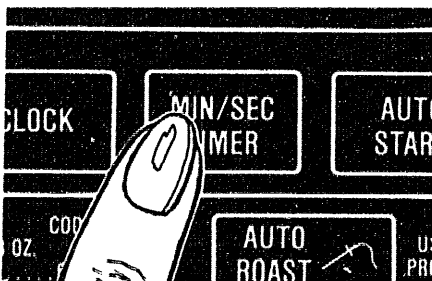

Step 4: Set standing or hold time by touching MIN/SEC TIMER. :0 appears on display and ENTER TIME flashes.

Step 5: Touch 1, 0, 0 and 0 to hold for ten minutes. 10:00 appears on display.

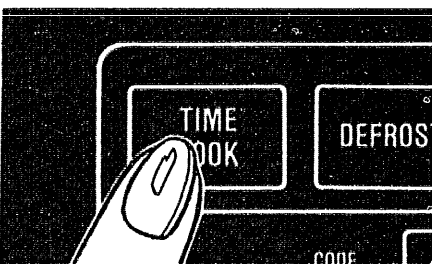

Step 6: Touch TIME COOK pad. The display shows :0 and ENTER COOK TIME flashes.

Step 7: Touch 2, 5, 0 and 0 for twenty-five minutes of cooking time. 25:00 appears on display.

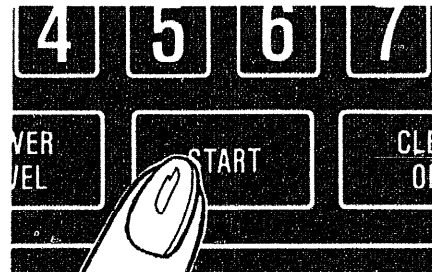

Step 8: Touch START. 15:00 counting down shows on display. As each function is automatically performed oven display shows instructions entered and the function. While cooking, you may touch appropriate pad to recall times you set.

Step 9: When time is up, the oven sounds, oven light and fan shut off. The display will show "End".

Step 10: Open the door or touch CLEAR/OFF pad.

Questions and Answers

Q. What will happen if I accidentally reverse my defrost, hold and cook instructions?

A. The oven automatically rearranges your program. Defrosting always comes first, then hold, and then the cooking function.

Q. Can I defrost and hold only?

A. Yes. Sometimes you may only want to defrost a food, hold it, and cook it later. All you need to do is program in Defrost and amount of time. Then program Hold and the amount of time. Be sure to put the thawed dish in the refrigerator promptly.

NOTE: Let foods remain at room temperature only as long as safe. Times will vary.

Q. I programmed my oven for a specific defrosting time but it defrosted longer than necessary. What happened?

A. When instructions conflict, the oven carries out the last instruction. You may have set the oven to defrost for 4 minutes, hold for 2 minutes, and then defrost for 6 minutes. In this case, the oven would defrost for 6 minutes and hold for 2 minutes and ignore your first defrost instruction.

How to Use COOK CODE™ Control

The COOK CODE™ Control provides a short-cut method for entering time and the Power Level on your microwave oven. Cooking Codes are only used for recipes which need little or no attention, and which require no change of power level during cooking. Recipes which require additional ingredients, attention or change of power level during microwaving should be cooked in the usual manner. Also, recipes with cooking time of less than one minute or more than 99 minutes can not use Cooking Codes.

To understand the Cook Code control, it is important to know what the numbers mean and what the sequence is. The first and second numbers, if setting a 3 digit Cooking Code, indicate the amount of time you desire; the last control entry number is always the Power Level. For example, 125 means 12 minutes

at Power Level 5. NOTE: Your oven can only be programmed to 99 minutes when using the Cook Code control and the highest Power Level is 10 which is represented by "0". When setting a 2 digit Cook Code control entry, the first is time, the second is power level. For example, 50 means 5 minutes at Power Level 10.

On the following page is shown many frequently prepared foods and their codes. It's easy, though, to make Cooking Codes for many other recipes. Just select one or two digits representing the length of cooking time desired, and a final digit for the Power Level required. The Cooking Codes given on the chart are for the minimum time needed, to avoid overcooking which can dry out food and make it tasteless and tough. If you feel that more cooking is needed, add additional time by changing the first digit of

the Code. You cannot add seconds to the cycle time—Cooking Codes are for whole minutes only. If your recipe calls for Power Level changes or different amounts of time needed between addition of ingredients, you may set one Cooking Code for the first part of the recipe, then after completion, set another Cooking Code for that period of time and Power Level.

Remember that Cooking Codes are for microwaving by time only. If you are microwaving by temperature, you must use the Temp Cook or Auto Roast function.

When the oven completes COOK CODE™ program, it automatically shuts off. It will then display "End" and beep once a minute until you either open the door or touch the CLEAR/OFF pad.

For Example:

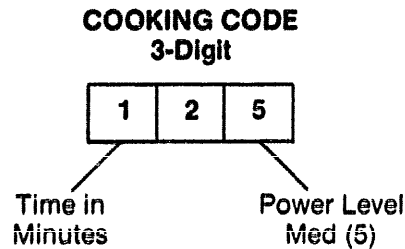
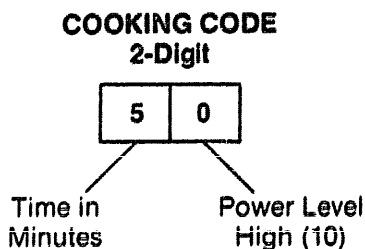

How to Set COOK CODE™ Control

Programming your oven for COOK CODE™ Control operation is easy. Follow these simple steps.

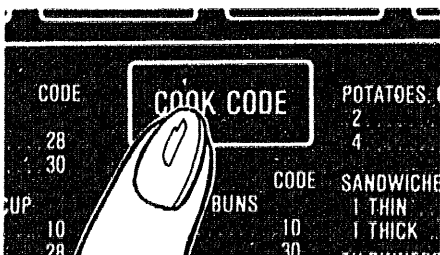

Step 1: Touch COOK CODE. ENTER CODE flashes.

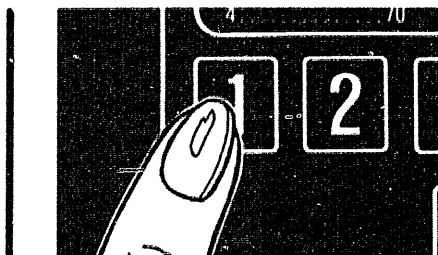

Step 2: Enter the proper code. For example, a recipe calling for 12 minutes cooking time at Power Level 10 would be 120. 120 appears on the display panel.

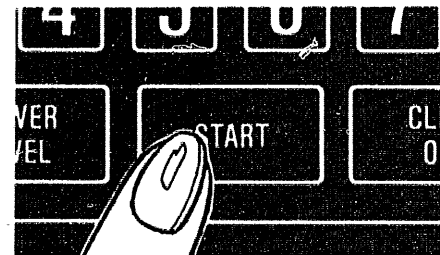

Step 3: Touch START. Display will show time counting down and COOK TIME.

COOK CODE™ Control Guide

Detach and Tape to Inside Cabinet Door or Other Prominent Place

The COOK CODE™ Control feature gives you an easy automatic way to accurately set microwave time for foods requiring only one power level and little attention during cooking. The Chart below shows frequently prepared foods and the suggested Cooking Codes to use with each. For specific information on stirring, turning or rotating, check the Microwave Guide and Cookbook which comes with your microwave oven. Always use microwave-safe containers

and microwave techniques as described in the Cookbook.

To set Cooking Codes for many other foods or recipes refer to page 14 in this *Use and Care Book*. COOK CODE™ Codes given are for minimum time. Check and add time if necessary to complete cooking.

FOOD	COOKING CODE
------	--------------

Appetizers (Warming)

Dip (Cream Cheese)	
½ Cup	25
1 Cup	45
Dips (Sour Cream)	
½ Cup	13
1 Cup	23
Pastry Bites (Reheating)	
2 Servings	17
4 Servings	10

Breads and Desserts

Apples	
(2)	40
Bran Muffins	
(5-6)	37
Brownies (Mix)	60
Cakes (Mix)	
(16 cup fluted mold)	110
Cheese Bread, Yeast	
(1 loaf)	105
Chocolate Chip Bars	50
Nut Bread (Mix)	
(1 loaf)	97
Pudding Mix (3 oz. pkg.)	60

Beverages

Coffee, Soup	
(1 Cup)	10
Milk Bases	
(1 Cup)	28

Frozen Foods (Defrost)

Note: Times given below are for entire defrost cycle. Usually food must be rotated, broken up or turned over while defrosting. Check Cookbook for specific information.

Cake, Whole Iced	23
Chicken, Cut-up	
(2½-3½ lbs.)	143
Dessert Topping, Whipped	13
Doughnuts or Pastries	
(2-4)	13
Fish Fillets	
(1 lb.)	83
Hamburgers	
(2 lbs.)	123
Pie, Fruit Filling	
(Whole)	83
Roast	
(4-5 lbs.)	403
Steak or Chops	
(2 lbs.)	83

FOOD	COOKING CODE
------	--------------

Meats/Main Dishes

Bacon	
2 Slices	28
4 Slices	30
Chicken	
8-10 pieces	200
2 pieces	40
4 pieces	70
Chuck Roast	
(3 lbs.)	665
Eggs, Baked	
2 Eggs	25
Eggs, Scrambled	
2 Eggs	20
Entrees, Frozen	
8 oz.	50
16 oz.	110
2 lbs.	200
Fish Fillets	
(1 lb.)	60
Franks (in bun)	
2	10
4	30
Meat Loaf	
(1½ lbs.)	170
Sausage (Raw)	
4 Patties	30
4 Links	20
Swiss Steak	
(2 lbs.)	706
Frozen TV Dinner	
(10 oz.)	107

Vegetables (Fresh)

Beans, Green	
(1 lb.)	150
Broccoli	
(1¼-1½ lbs.)	
Spears	157
Cut	120
Cauliflower, Head	137
Corn on Cob	
(4)	120
Potatoes	
(4)	120
Squash	
(1 lb.)	100
Zucchini	
(1 lb.)	100

Vegetables (Frozen)

10 oz. pkg.	70
-------------	----

CUT ALONG DOTTED LINE

Care for Your Microwave Oven

Your New Microwave Oven is a Valuable Appliance, Protect It From Misuse By Following These Rules:

- **Keep your oven clean and sweet-smelling.** Opening the oven door a few minutes after cooking helps "air-out" the interior. An occasional thorough wiping with a solution of baking soda and water keeps the interior fresh.
- **Don't use sharp-edged utensils with your oven.** The interior and exterior oven walls can be scratched. The control panel can be damaged.
- **Don't remove the mode stirrer** at the top of the oven (microwave feature 4 on page 5). You will damage the oven.

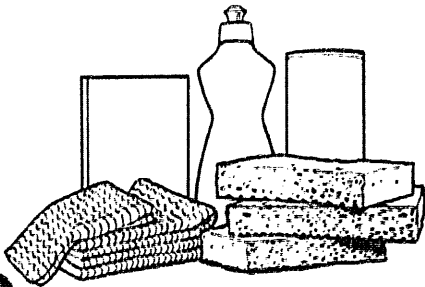

BE CERTAIN POWER IS OFF BEFORE CLEANING ANY PART OF THIS OVEN.

How to Clean the Inside

Walls, floor and plastic cover. Because there is little heat except in the food, or sometimes in the utensils, spills and spatters are easy to remove. Some spatters can be removed with a paper towel, others may require a damp cloth. Remove greasy spatters with a sudsy cloth, then rinse and dry. Do not use abrasive cleaners on oven walls. **NEVER USE A COMMERCIAL OVEN CLEANER ON ANY PART OF YOUR MICROWAVE OVEN.**

Door-Inside. Glass: Wipe up spatters daily, wash when soiled, with a minimum of sudsy warm water. Rinse thoroughly and dry.

Metal and plastic parts on door: Wipe frequently with a damp cloth to remove all soil. **DO NOT USE ABRASIVES, SUCH AS CLEANING POWDERS OR STEEL AND PLASTIC PADS. THEY MAY MAR THE SURFACE.**

Special note when using Brown 'N Sear Dish: High heat generated on bottom of Brown 'N Sear Dish can cause scorched appearing stains to bake onto the oven floor if grease is present. These may be removed with Bar Keepers Friend® Cleanser by SerVaas Laboratories, Inc.

After using Bar Keepers Friend® Cleanser, rinse and dry thoroughly, following instructions on can. Do not use Bar Keepers Friend® Cleanser on the painted surfaces such as the walls. It may scratch the paint.

Bar Keepers Friend® Cleanser is sold in many grocery, hardware, and department stores.

Two Position Metal Shelf. Your metal shelf accessory is designed for use in a microwave oven only; do not use in a conventional oven. Do not use a browning dish with the shelf. Arcing could occur. Clean shelf with mild soap and water or in the dishwasher. **Do not clean in self-cleaning oven.**

Automatic Temperature Probe. Probe is sturdy, but care should be taken in handling. Do not twist or bend; avoid dropping temperature probe.

Clean as soon after using as possible. To clean, wipe with sudsy cloth, then rub lightly with plastic scouring ball if necessary. Rinse and dry. (Or wash in dishwasher.)

How to Clean the Outside

Case. Clean the outside of your oven with soap and damp cloth, then rinse and dry. The outer pane of the window is glass. Just wipe clean with a damp cloth. Chrome trim is best wiped with a damp cloth and then with a dry towel.

Control Panel. Wipe with a damp cloth. Dry thoroughly. Do not use abrasives or sharp objects on the panel. They can damage it.

Door Surface. When cleaning surfaces of door and oven that come together on closing the door, use only mild, non-abrasive soaps or detergents applied with a sponge or soft cloth.

Power Cord. If the cord becomes soiled, unplug and wash with damp cloth. For stubborn spots, sudsy water may be used, but be certain to rinse and dry thoroughly before plugging cord into outlet.

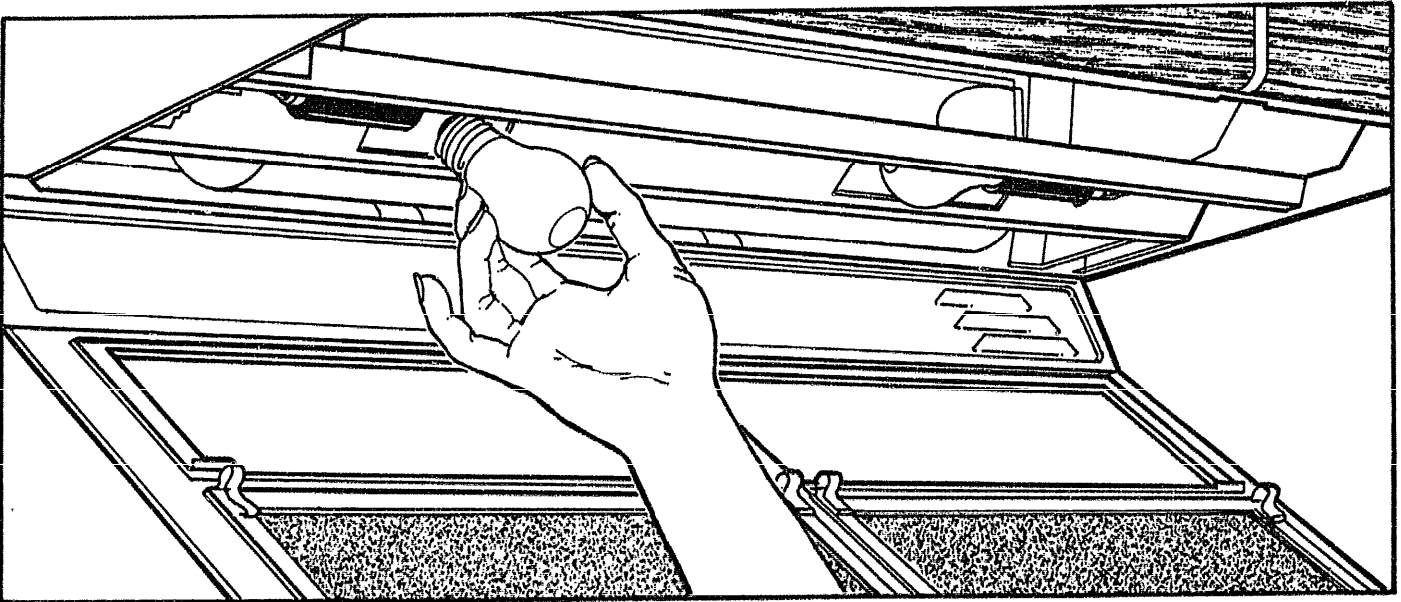

To replace hood lamp, first disconnect power at main fuse or circuit breaker panel or pull plug. Remove 2 screws from each side of lower panel and 3 screws from front edge. Lower panel until it rests on range

below. Be sure bulb to be replaced is cool before removing. Remove bulb or bulbs and replace with 40 watt appliance bulbs. Raise lower panel and replace screws. Connect electrical power to microwave oven.

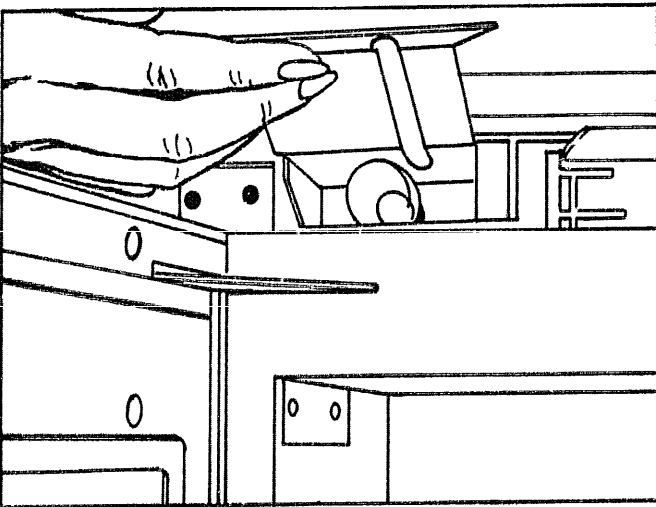

To replace you oven lamp, first disconnect power at main fuse or circuit breaker or pull plug. Remove the top grill by taking off 2 screws which hold it in place. Next, remove the single screw on top left that secures lamp housing. (On models so equipped.) Open oven door for easier removal of the lamp housing assembly. Then grasp tab and pull out and up to clear door hinge and front lip of oven. To remove bulb, push it inward gently and turn to left, then pull outward from socket. Replace with GE Lamp #25T8DC.

Do not attempt to operate the oven unless the grill is in place.

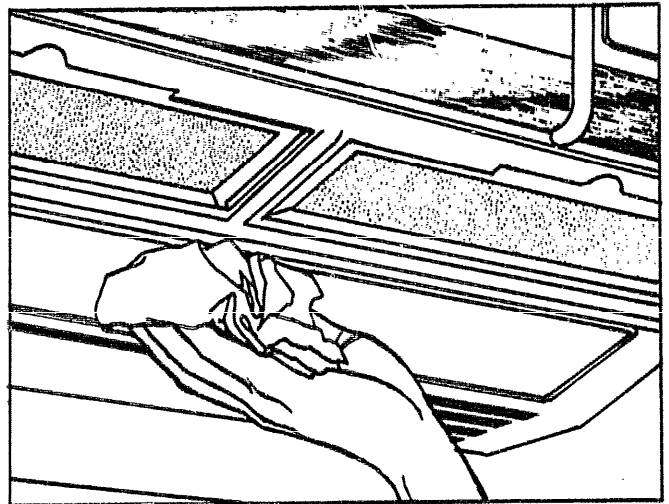

Clean off the grease and dust on hood surfaces often. Use a warm detergent solution. About 1 tablespoon of ammonia may be added to the water. Take care not to touch the filters and enameled surfaces with this. Ammonia will tend to darken metal.

The Exhaust Feature

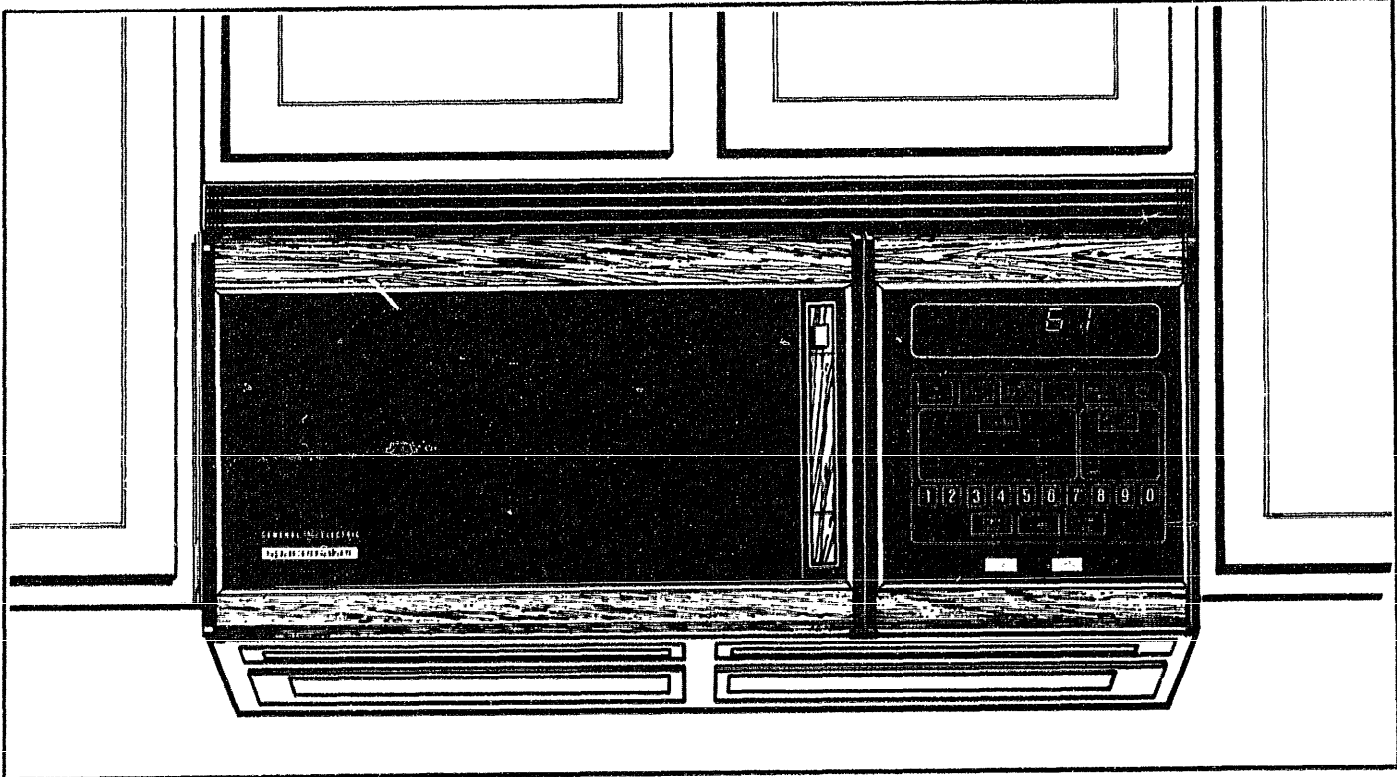

The exhaust hood feature on your GE microwave oven is equipped with a metal filter which collects grease. When the fan is operated, air is drawn up

through the filter and is then discharged through provided venting to the outside. The hood also has a light for illuminating the counter surface.

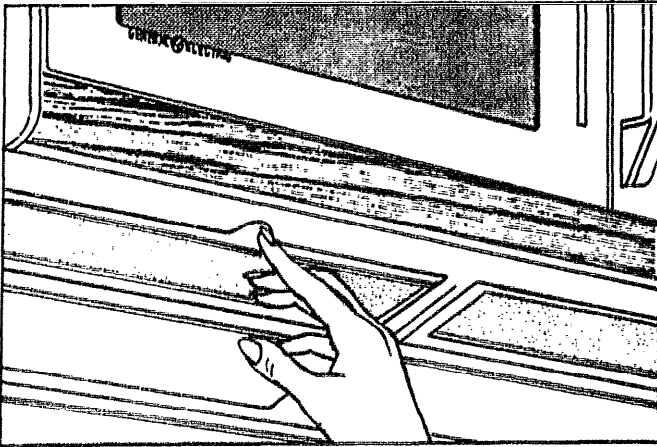

To remove grease filter, grasp the "finger hold" on the filter and push to the rear. The filter will drop out.

To replace grease filter, insert the filter in the top frame slot on the back of the opening. Push to the rear and upward to snap into place.

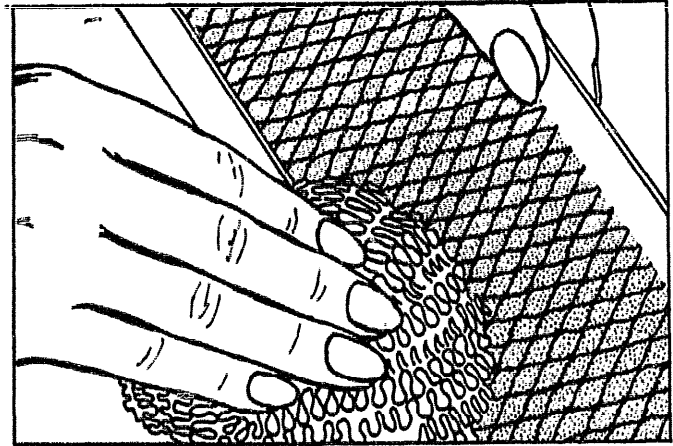

Soak, then agitate filter in hot detergent solution. Don't use ammonia or other alkali because it will darken metal. Light brushing can be used to remove embedded dirt. Rinse, shake and remove moisture before replacing. **Filters should be cleaned at least once a month. Never operate your hood without the filter in place.** In situations where flaming might occur on surfaces below hood, filter will retard entry of flames into the unit.

Guide to Use of the Spacemaker® Shelf

The two-position wire shelf is specifically designed for added capacity heating and reheating in your Spacemaker® microwave oven. Now heating and reheating, which are the most popular uses of microwave ovens, may now be done in multiple quantities, so several foods are ready to serve at the same time.

When microwaving with the oven shelf, some techniques will differ from the cookbook which came with your oven. It is important to arrange foods properly, and this is shown on the next page. Utensil size is important; select from among the suggestions below. Also, food size should be considered; foods over 3½ inches high, or 3 pounds are not recommended for shelf cooking.

Batters and dough foods and also foods for oven meals using scratch recipes should be cooked without the oven shelf, following cookbook directions.

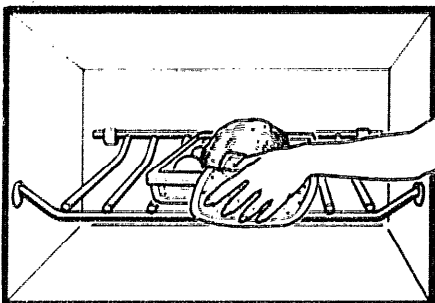

Use potholders when handling foods heated together with your oven shelf, especially when heating larger amounts of food in 8 inch square or other 2 quart size casseroles. Extra steam generated from multiple food cooking may make utensils hotter than with regular microwaving.

- Do not store or cook with metal shelf on floor of oven. Product damage may result.
- Use potholders when handling metal shelf and utensils. They may be hot.
- Do not store microwave browning dish on metal shelf.

Utensils for Shelf Heating and Reheating

Before placing food in the dishes you plan to use for shelf microwaving, check to see that they will fit together on or under the shelf. Also, be sure utensils are microwave safe.

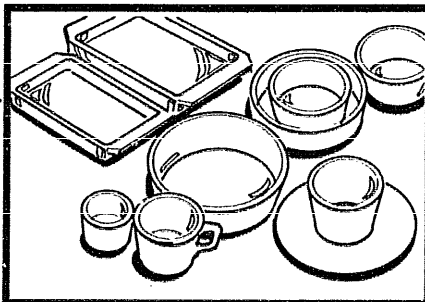

Casseroles for heating or reheating include 1 cup measuring cup, 8x4x3-inch loaf dishes, 9x5x3-inch loaf dishes or 9-inch pie plates.

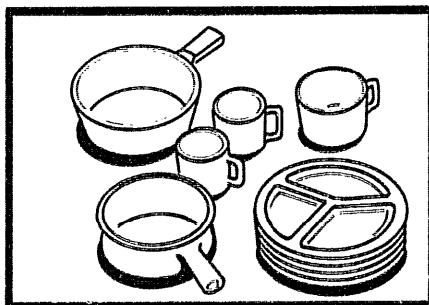

Leftovers may be placed in small individual ceramic or plastic bowls or divided plates.

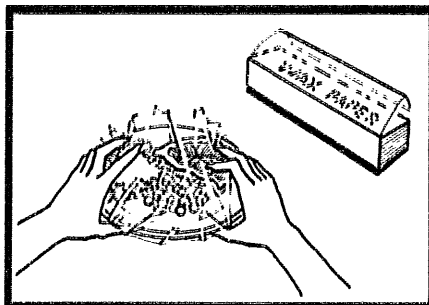

Use wax paper or plastic wrap instead of lids on casseroles. Lids may add too much height to dish.

Shelf Positioning

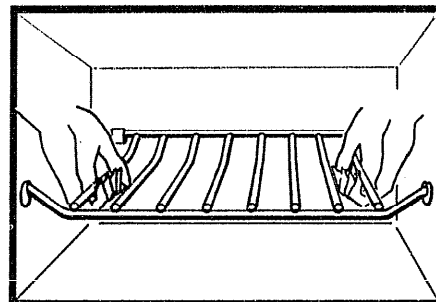

To insert shelf, tip back slightly and fit into shelf supports on back oven wall. Set front of shelf on side supports as shown.

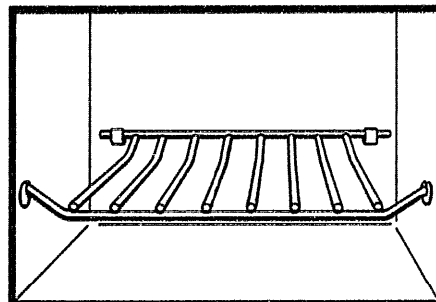

Shelf has two positions. Use in low position when heating two casseroles or reheating frozen TV dinners or entrees.

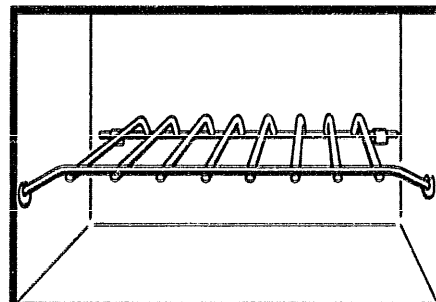

The high shelf position more evenly spaces the area above and below shelf. Use this position for heating plates of leftovers.

How To Heat or Reheat Similar Types of Food

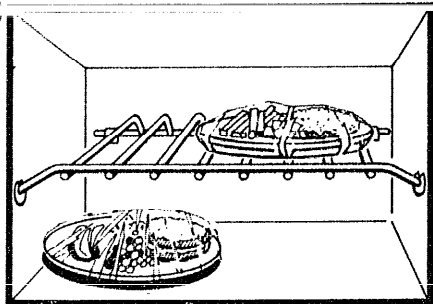

Two plates of leftovers may be reheated together. Arrange thick or dense foods to outside edges of plate and cover with plastic wrap. Microwave at HIGH (10) for 3 minutes. Reverse position of plates (top to bottom) and rotate $\frac{1}{2}$ turn. Continue microwaving at HIGH (10) for 3 to 4 minutes. Continue heating, if necessary, until hot.

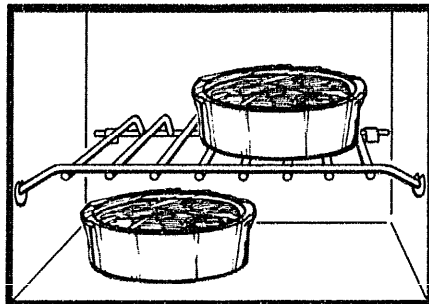

Reheating two casseroles (height should be less than $3\frac{1}{2}$ inches) is now possible. Cover with plastic wrap. Use staggered arrangements of food, placing food on right side of shelf and left side of floor. Refer to Heating or Reheating Guide (see inside front cover of cookbook) for suggested microwave time per casserole and add together the times. Microwave at HIGH (10), reversing position of foods (top to bottom) after half of time. Also, heat several smaller bowls of leftovers this way, stirring and reversing positions after half of time.

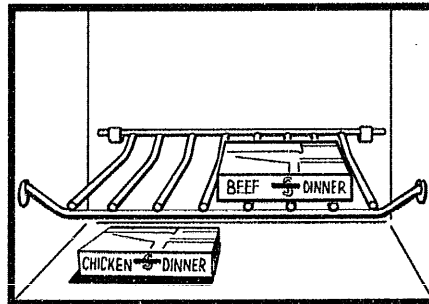

Two frozen individual entrees (5 to 7 oz. ea.) or two TV dinners (10 to 12 oz. ea.) are both ready to serve at the same time. Remove batter foods; cook these conventionally. Return foil trays containing food to boxes in which they were purchased. Place in oven with one TV dinner on right shelf and the second dinner on left floor. Microwave at HIGH (10) for 6 minutes. Reverse positions (top to bottom) and rotate foods $\frac{1}{2}$ turn. Continue microwaving at HIGH (10) for 6 minutes. Check dinners for heating. If one dinner seems less done than desired, return it to the box and continue heating on shelf 1 to 2 more minutes.

How To Reheat Several Different Types of Foods Together

When heating several different types of food together, foods which should be served hot must be placed on the oven shelf, while foods which are only warmed should be placed on the floor. This is because microwave energy enters the oven from the top only. Also, it is important to remember that foods absorb microwave energy at different rates. Rates can be affected by the size of the food, and its starting temperature.

Because of the varying rates you may need to start reheating a large or dense food a few minutes ahead of time, then add other smaller or less dense foods. Alternately, if one of the several foods you are heating seems under cooked but the others are heated satisfactorily, let the underheated food continue cooking.

Heat or reheat different types of food at HIGH (10). To determine heating times, add together times for all foods. (See heating guide inside front cover of cookbook.) After half of time, stir or rearrange foods (do not reverse positions). Check foods (top shelf especially) after $\frac{3}{4}$ of total time and remove any which are done. Continue cooking others.

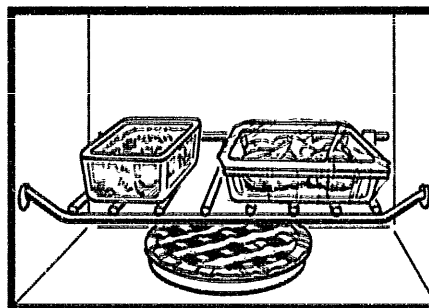

Place on shelf large or dense foods which need the most heating, such as leftover fried chicken, casseroles of canned or leftover vegetables, rice or pasta. Place on oven floor those foods which need only be warmed, such as bakery pies, rolls, muffins or breads.

GROUNDING INSTRUCTIONS

This appliance must be grounded. In the event of an electrical short circuit, grounding reduces the risk of electric shock by providing an escape wire for the electric current. This appliance is equipped with a power cord having a grounding wire with a grounding plug. The plug must be plugged into an outlet that is properly installed and grounded. (Fig. 1)

WARNING—Improper use of the grounding plug can result in a risk of electric shock.

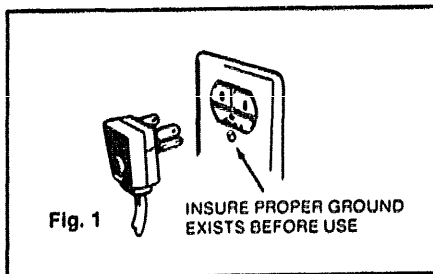

Consult a qualified electrician or service technician if the grounding instructions are not completely understood, or if doubt exists as to whether the appliance is properly grounded.

Where a standard two-prong wall receptacle is encountered, it is your personal responsibility and obligation to have it replaced with a properly grounded three-prong wall receptacle.

Do Not Under Any Circumstances Cut or Remove the Third (Ground) Prong From The Power Cord.

Do Not Use an Adapter Plug With This Appliance.

Do Not Use an Extension Cord With This Appliance.

The Problem Solver

To Save Time and Money—before you request service, check the Problem Solver

If you have a problem, it may be minor. You may be able to correct it yourself. Just use this Problem Solver to locate your problem and then follow the suggested recommendations.

All These Things Are Normal on Your Microwave Oven:

- Steam or vapor escaping from around the door.
- Light reflection around door or outer case.
- Dimming oven light and change in blower sound may occur while operating at power levels other than high.
- Dull thumping sound while operating at power levels other than high.
- Some TV-Radio interference might be noticed while using your microwave oven. It's similar to the interference caused by other small appliances and does not indicate a problem with your oven.

PROBLEM	POSSIBLE CAUSE AND REMEDY
OVEN WILL NOT COME ON	<p>A fuse in your home may be blown or the circuit breaker tripped. Replace fuse or reset circuit breaker.</p> <p>Make sure 3-prong plug on oven is fully inserted into wall receptacle.</p>
CONTROL PANEL LIGHTED, YET OVEN WILL NOT START	<p>Door not securely closed.</p> <p>START must be touched after entering cooking selection.</p> <p>Another selection entered already in oven and CLEAR/OFF not touched to cancel it.</p> <p>Make sure you have entered cooking time after touching TIME COOK.</p> <p>CLEAR/OFF was touched accidentally. Reset cooking program and touch START.</p> <p>Make sure you have entered desired finished temperature after touching TEMP COOK/HOLD.</p> <p>Make sure you have entered a code number after touching COOK CODE™ or AUTO ROAST.</p>
FOODS ARE EITHER OVER-COOKED OR UNDERCOOKED	<p>Cooking times may vary because of starting food temperature, food density or amount of foods in oven. Touch TIME COOK and additional cooking time for completion.</p> <p>Incorrect Power Level entered. Check Cookbook for recommended Power Level or changing levels during cooking if necessary.</p> <p>Dish was not rotated, turned or stirred. Some dishes require specific instructions. Check Cookbook or recipe for these instructions.</p> <p>Too many dishes in oven at same time. Cooking time must be increased when cooking more than one food item. Check Cookbook for recommendation on increasing time.</p> <p>Probe not inserted properly into meat or dish when using Temp Cook/Hold or Auto Roast functions. Check Cookbook for specific instructions.</p> <p>Incorrect COOK CODE™ numbers entered.</p>
"EE EE" APPEARS ON DISPLAY	<p>When using Temp Cook/Hold, a temperature less than 90° or more than 199° has been entered.</p> <p>When using Auto Start, you have not entered a valid clock time.</p> <p>When using Clock, you have not entered a valid clock time.</p> <p>When using COOK CODE™, you have not entered a valid Cook Code. Cook Code must be 2 or 3 digits.</p>
"PR OB" APPEARS ON DISPLAY	<p>Probe has been forgotten or not seated properly in oven wall when using Auto Roast or Temp Cook/Hold functions.</p>



Consumer Services

Our Consumer Services are designed with your needs and wants in mind.

1.

Warranty Protection

Before your new appliance left the factory, it went through rigorous tests to detect manufacturing defects.

And you have a written warranty to protect you. See the warranty on the back page of this book for details.

2.

Convenient Service

Whether your appliance is in or out of warranty, you're just a phone call away from our nationwide network of Factory Trained Service professionals.

Simply call our GE service organization. Look in the White or Yellow Pages of your telephone directory for GENERAL ELECTRIC COMPANY, GENERAL ELECTRIC FACTORY SERVICE, GENERAL ELECTRIC-HOTPOINT FACTORY SERVICE or GENERAL ELECTRIC CUSTOMER CARE® SERVICE.

Service can normally be scheduled at your convenience and the technician drives a fully-stocked parts service truck so that, in most cases, the repair can be completed in one visit.

We're proud of our service and want you to be pleased, but if for some reason you are not happy with the service you receive, here are three steps to follow for further help.

FIRST, contact the people who serviced your appliance. Explain why you are not pleased. In most cases, this will solve the problem.

NEXT, if you are still not pleased write all the details—including your phone number to:

Manager, Consumer Relations
General Electric
Appliance Park
Louisville, Kentucky 40225

FINALLY, if your problem is still not resolved, write:

Major Appliance Consumer Action Panel
20 North Wacker Drive
Chicago, Illinois 60606

3.

Service Contracts

For trouble-free service beyond the written warranty period.

If you prefer to budget your repair expenditures instead of being surprised by them, GE offers service contracts for varying lengths of time on all GE major appliances. With a contract, we'll keep your appliance in good operating condition during the contract period at no additional charge.

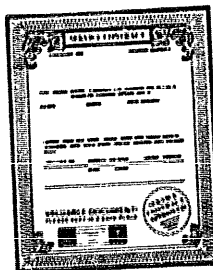

Service contracts let you pay today's prices for service a month, a year, or several years from now. And, you'll receive service from GE trained service technicians using only genuine GE parts. If you have any questions about Service Contracts, call **TOLL-FREE** 800.626.2224. (In Kentucky, call 800.292.2057.)

4.

The Quick Fix® System

You can save money and time by doing it yourself.

For do-it-yourselfers who would prefer to fix GE major appliances themselves... GE offers an industry first, the Quick Fix® System.

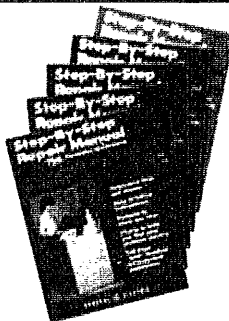

A program for do-it-yourself appliance repair, the system includes *step-by-step repair manuals* for refrigerators, most non-microwave electric ranges, dishwashers, and standard and large capacity washers and dryers, plus *specialty packaged replacement parts*, and technical help with a *toll-free 800 number*.

5.

Help for You by Phone

Should you need help in the selection and purchase of new appliances, or have questions about the operation of the GE appliances you now own—or have *any* other questions about GE consumer products or services, you are only a **TOLL-FREE** call away.

The GE Answer Center™ consumer information service is open 24 hours a day, seven days a week.

Our staff of experts stands ready to assist you anytime.



Your Direct Line to General Electric
The GE Answer Center® 800.626.2000

WARRANTY

Save proof of original purchase date such as your sales slip or cancelled check to establish warranty period.

WHAT IS COVERED**FULL ONE-YEAR WARRANTY**

For one year from date of original purchase, we will provide, free of charge, parts and service labor in your home to repair or replace **any part of the microwave oven/range** that fails because of a manufacturing defect.

LIMITED ADDITIONAL FOUR-YEAR WARRANTY

For the second through fifth year from date of original purchase, we will provide, free of charge, a replacement **magnetron tube** if the magnetron tube fails because of a manufacturing defect. You pay for the service trip to your home and service labor charges.

This warranty is extended to the original purchaser and any succeeding owner for products purchased for ordinary home use in the 48 mainland states, Hawaii and Washington, D.C. In Alaska the warranty is the same except that it is **LIMITED** because you must pay to ship the product to the service shop or for the service technician's travel costs to your home.

All warranty service will be provided by our Factory Service Centers or by our authorized Customer Care[®] servicers during normal working hours.

Look in the White or Yellow Pages of your telephone directory for **GENERAL ELECTRIC COMPANY, GENERAL ELECTRIC FACTORY SERVICE, GENERAL ELECTRIC-HOTPOINT FACTORY SERVICE or GENERAL ELECTRIC CUSTOMER CARE[®] SERVICE.**

WHAT IS NOT COVERED

- Service trips to your home to teach you how to use the product.

Read your Use and Care material.

If you then have any questions about operating the product, please contact your dealer or our Consumer Affairs office at the address below, or call, toll free:

The GE Answer Center™
800.626.2000
consumer information service

- Improper installation.

If you have an installation problem, contact your dealer or installer. You are responsible for providing adequate electrical, exhausting and other connecting facilities.

- Replacement of house fuses or resetting of circuit breakers.

- Failure of the product if it is used for other than its intended purpose or used commercially.

- Damage to product caused by accident, fire, floods or acts of God.

WARRANTOR IS NOT RESPONSIBLE FOR CONSEQUENTIAL DAMAGES.

Some states do not allow the exclusion or limitation of incidental or consequential damages, so the above limitation or exclusion may not apply to you. This warranty gives you specific legal rights, and you may also have other rights which vary from state to state. To know what your legal rights are in your state, consult your local or state consumer affairs office or your state's Attorney General.

Warrantor: General Electric Company

if further help is needed concerning this warranty, contact:

Manager—Consumer Affairs, General Electric Company, Appliance Park, Louisville, KY 40225